

# Ranger Derby Car Layout Kit 2019

Max width 2.75"

Max Height 3"

Max Length 7.5"

Max Weight 5.5 oz

All outside lines show maximum dimensions

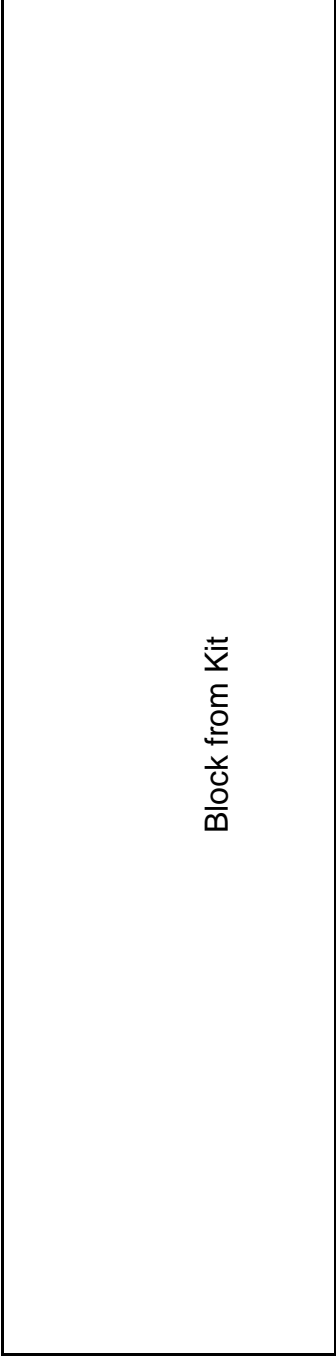

Block from Kit

Top view no bigger than outside line

You can enter a picture into these fields as well

End View no bigger than outside line

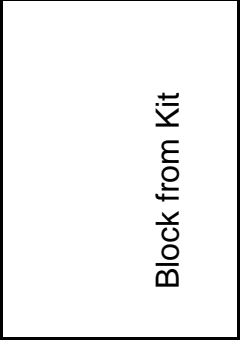

Block from Kit

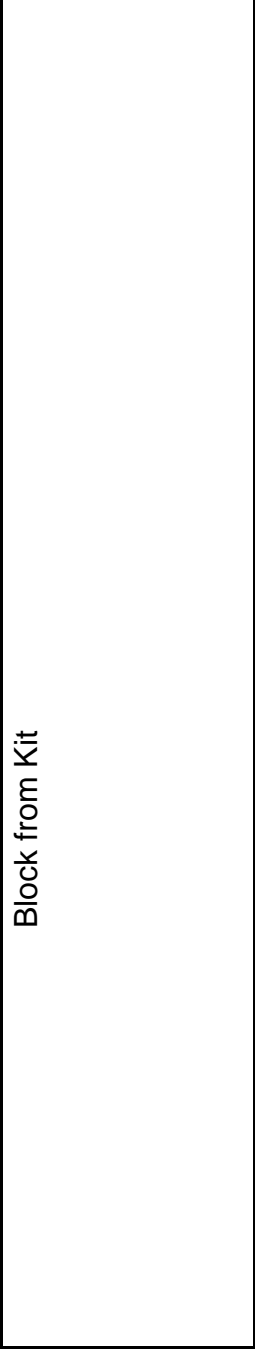

Block from Kit

Side View No bigger than outside line

**Have them draw on this sheet and then cut out the rectangle and tape it to the block of wood for cutting.**



**Specifications for car. I like to photocopy their drawing first before they cut it out to show them their design after the car is made.**



1. Finished dimensions not to exceed: Width-2 3/4"; Length- 7 1/2" ; Height- 3" Weight- 5.5oz
2. Wheel bearings, washers, and bushings not allowed.
3. Lubricating is permissible. Graphite is the best, not oil.
4. Car must be free wheeling - no starting attachments allowed.

**Rangers Name: \_\_\_\_\_**

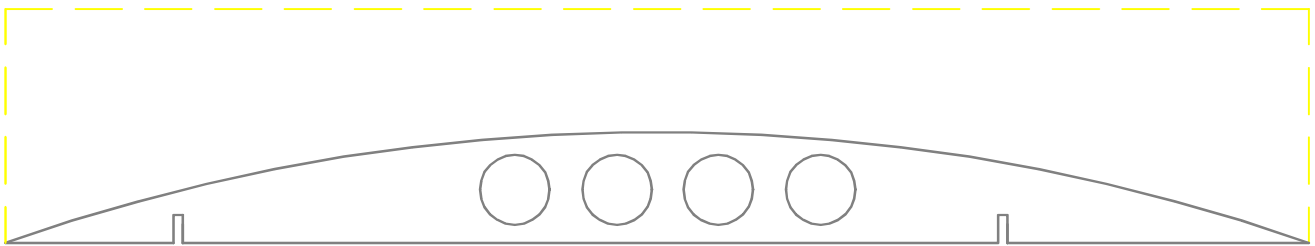
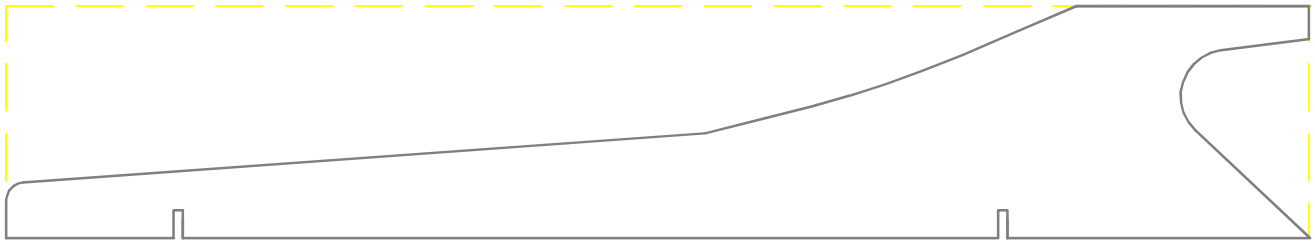

3/8" HOLES FOR WEIGHT



GLUE EXTRA WOOD TO BLOCK FOR REQUIRED HEIGHT

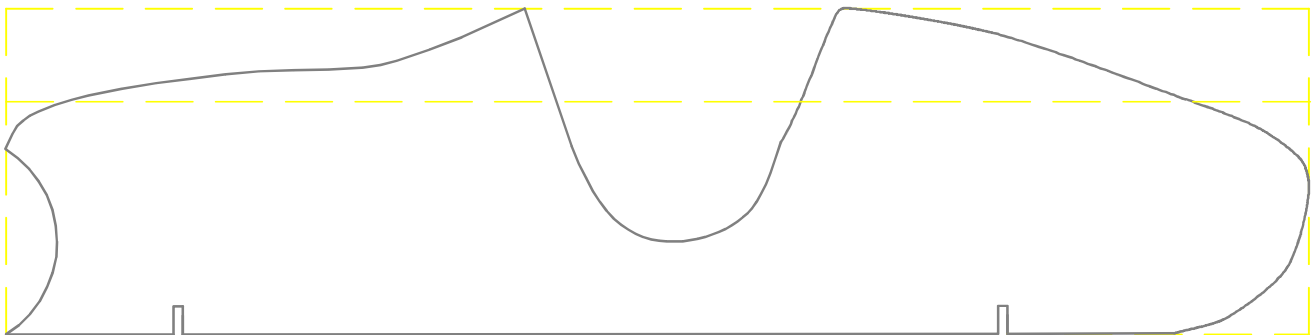

GLUE EXTRA WOOD TO BLOCK FOR REQUIRED HEIGHT

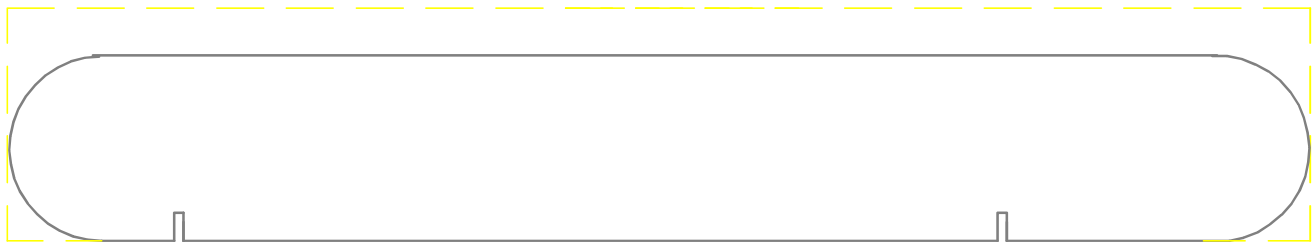
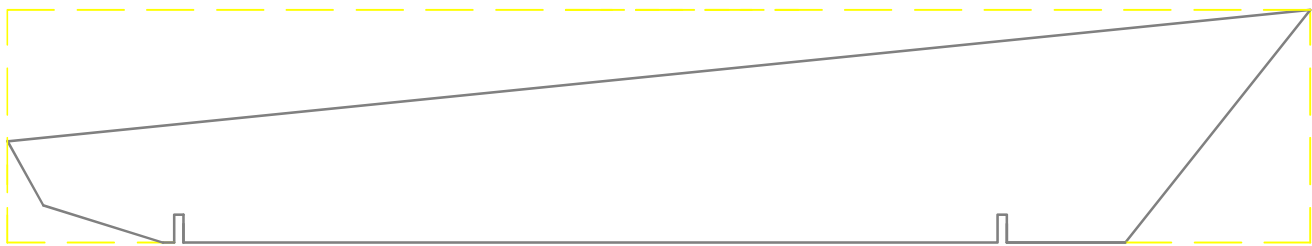
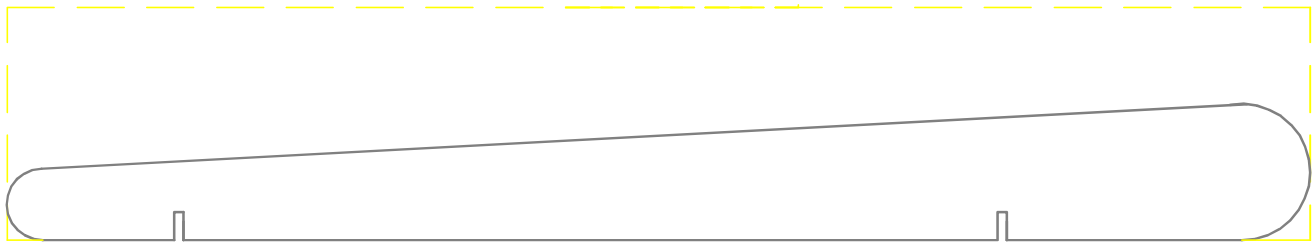
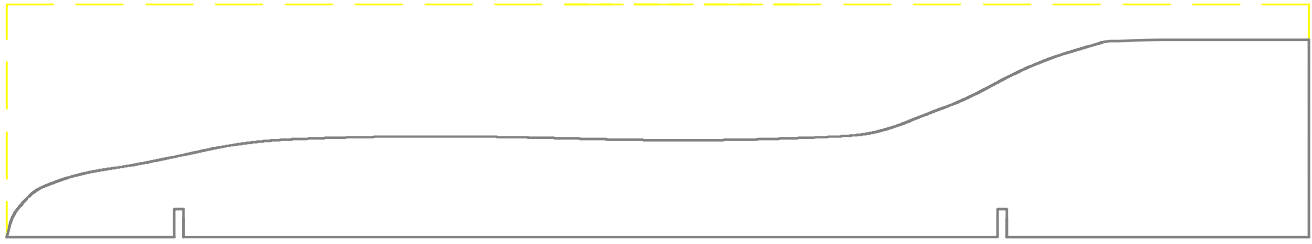

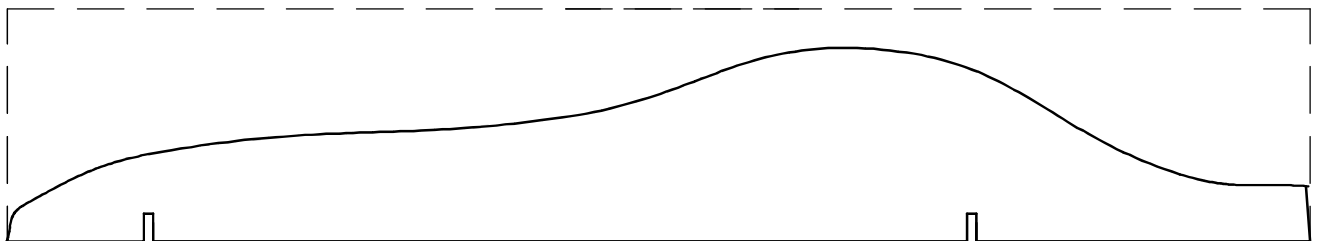
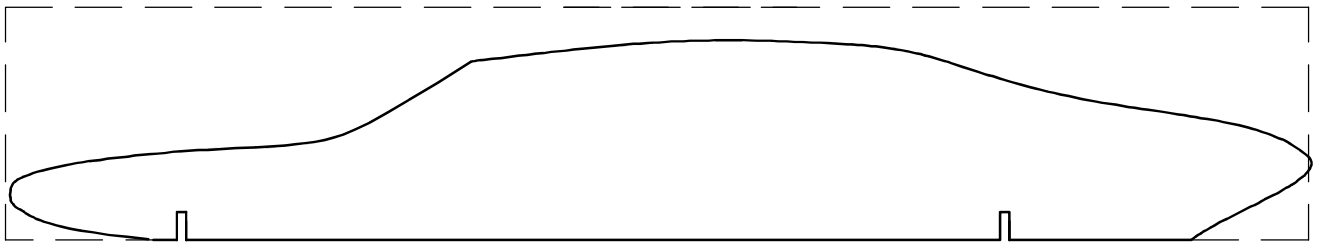
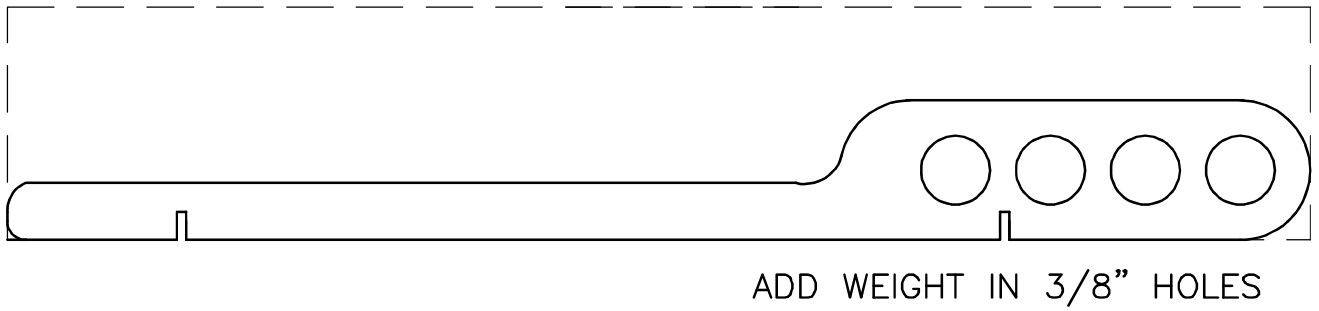
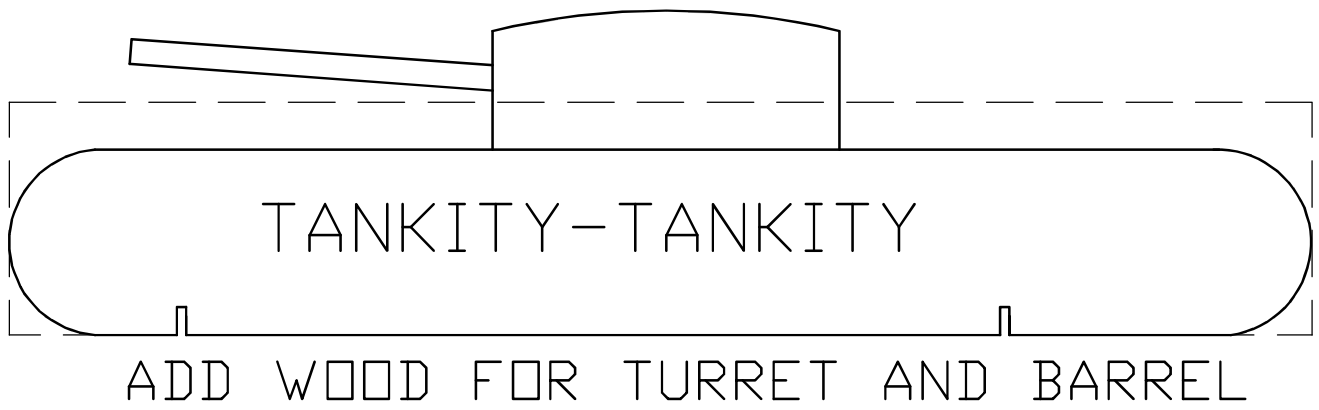

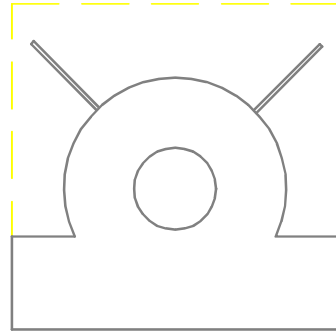
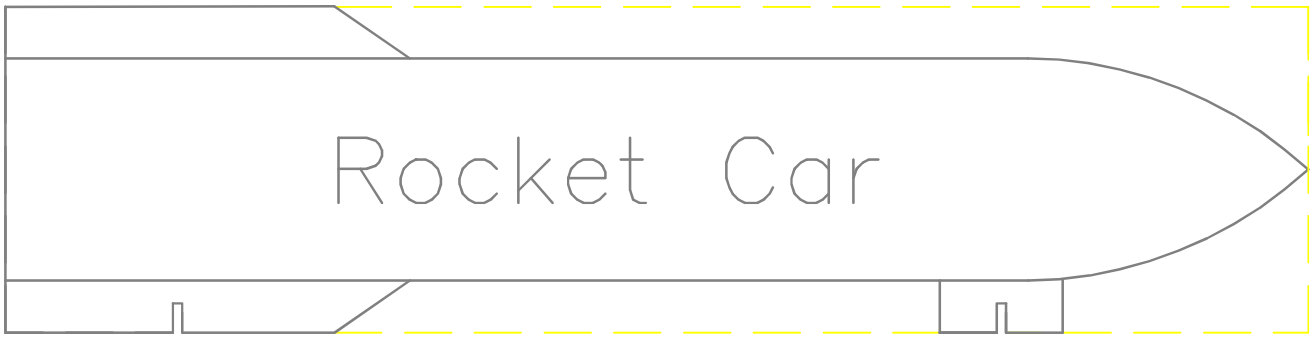

END VIEW

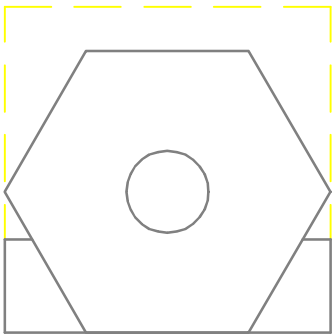

END VIEW

GLUE ADDITIONAL WOOD FOR THESE DESIGNS

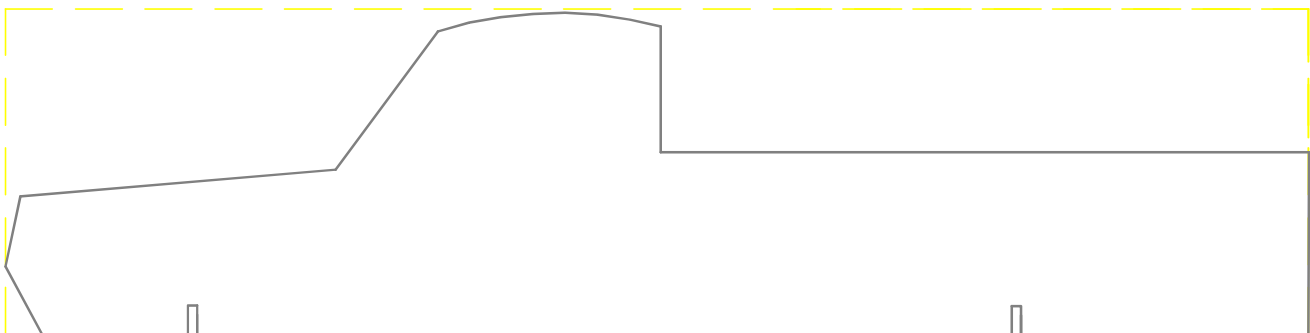
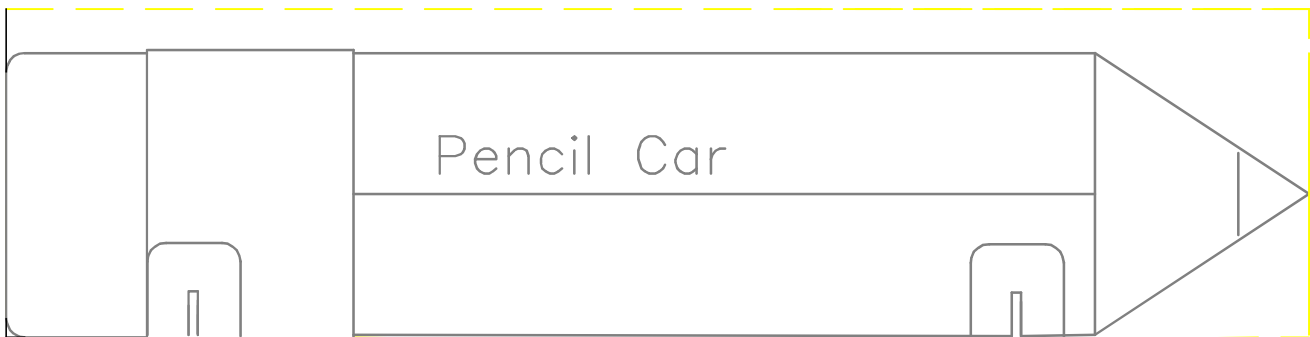

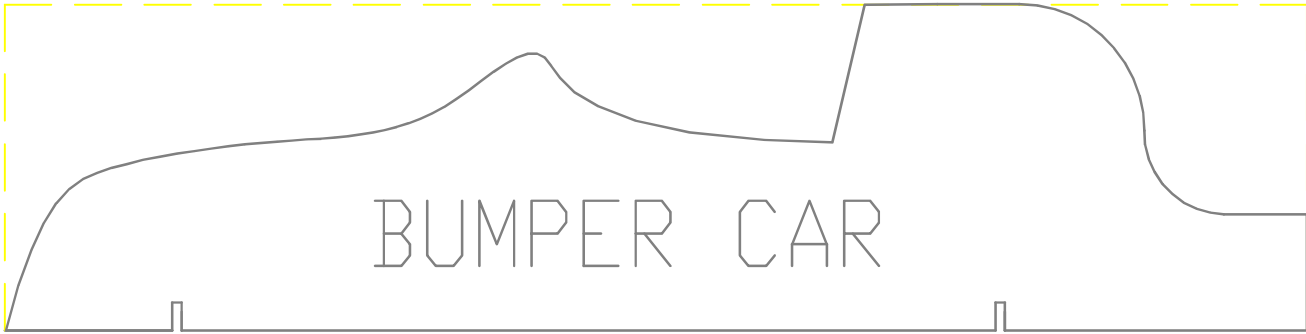

GLUE EXTRA WOOD FOR ADDITIONAL HEIGHT

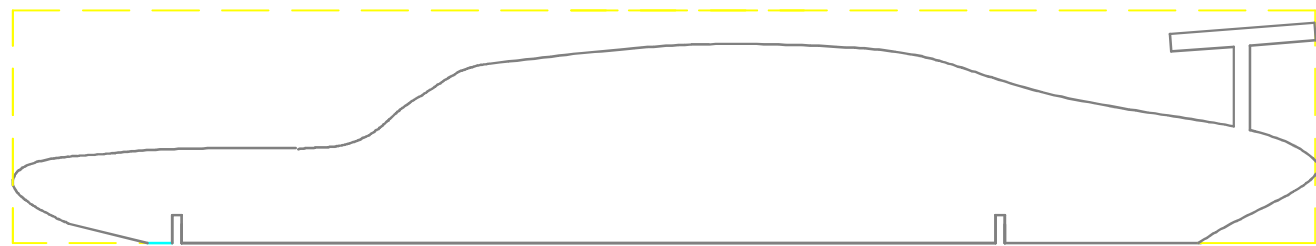

GLUE ON ROUNDED 1/2" DOWEL

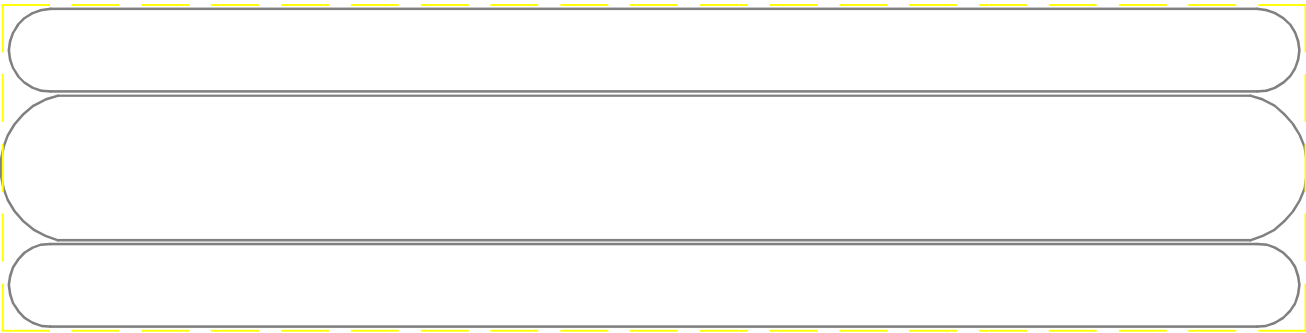
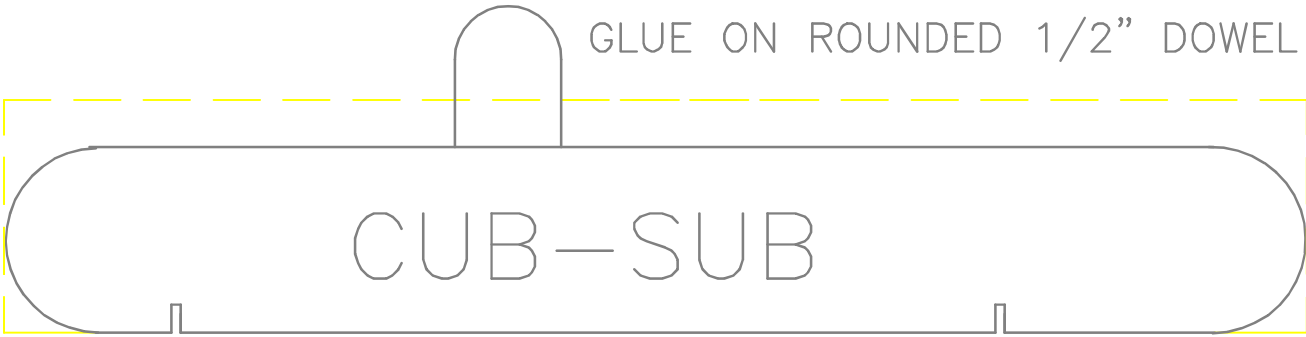

HOTDOGGER TOP VIEW

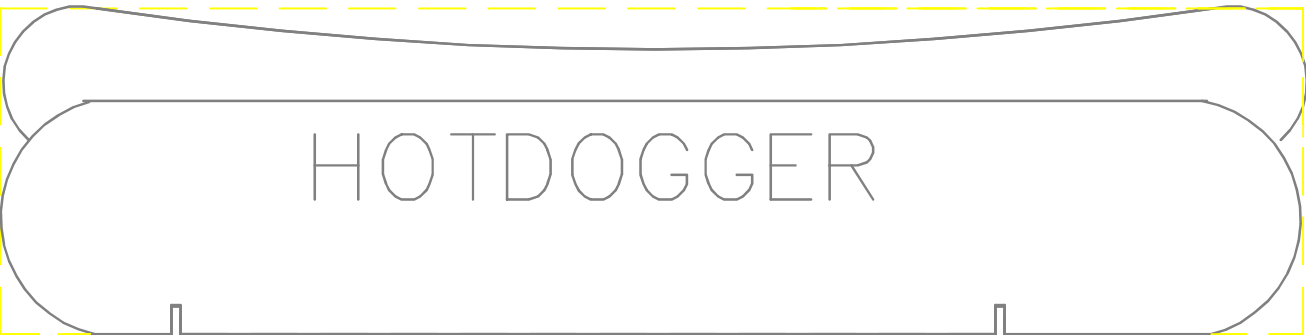

GLUE ADDITIONAL WOOD FOR HEIGHT

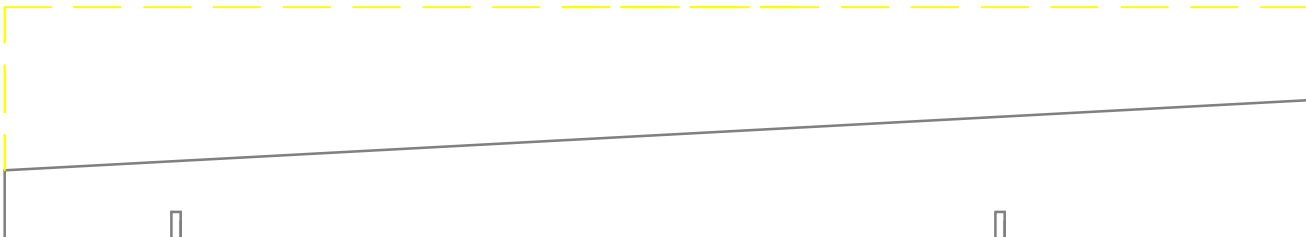



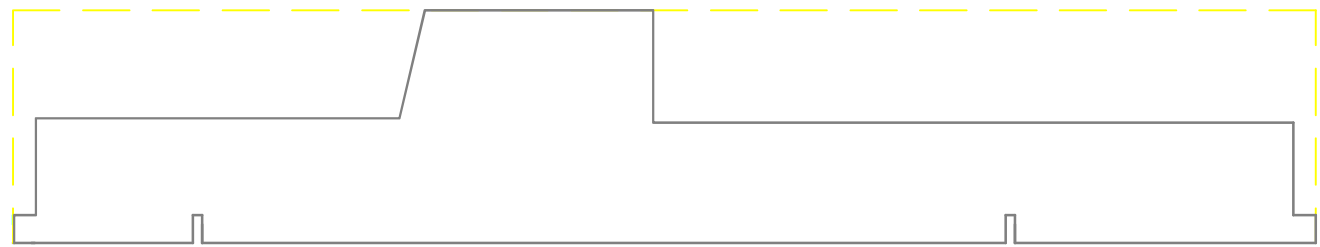
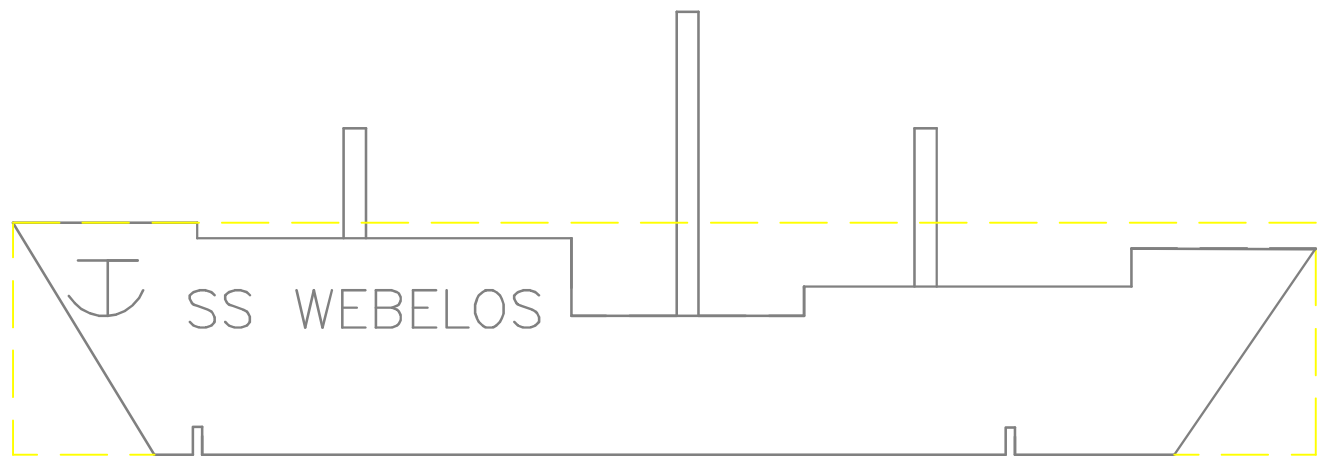
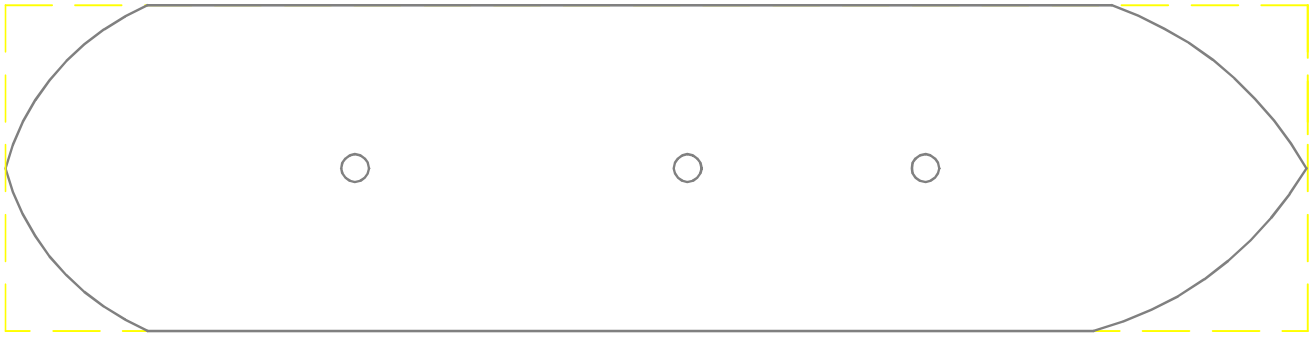

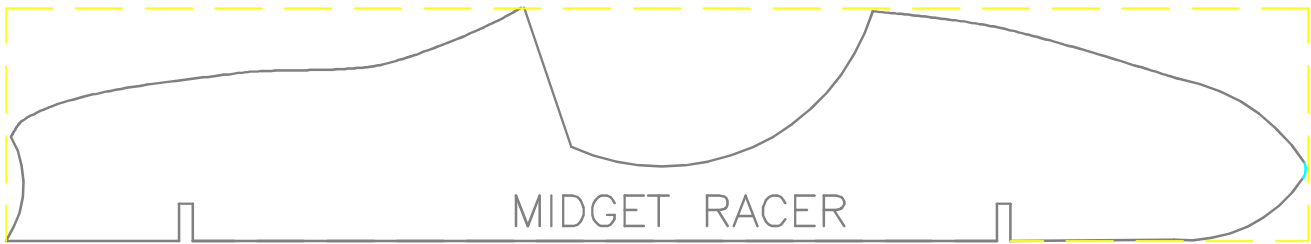

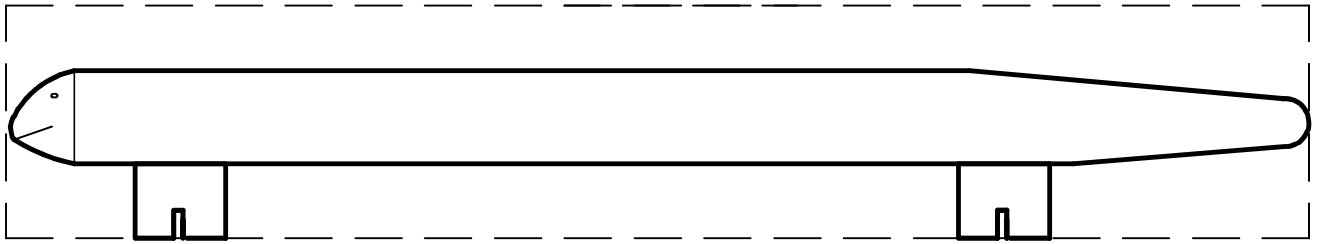

"SNEAKY SNAKE SIDE VIEW"

FRAGILE DESIGN, USE REINFORCEMENT

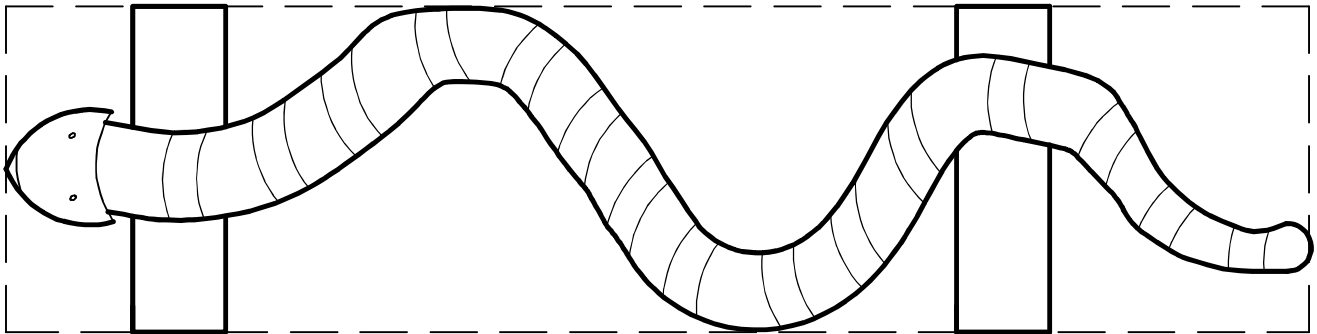

"SNEAKY SNAKE TOP VIEW"

1/8" WOOD DOWELS

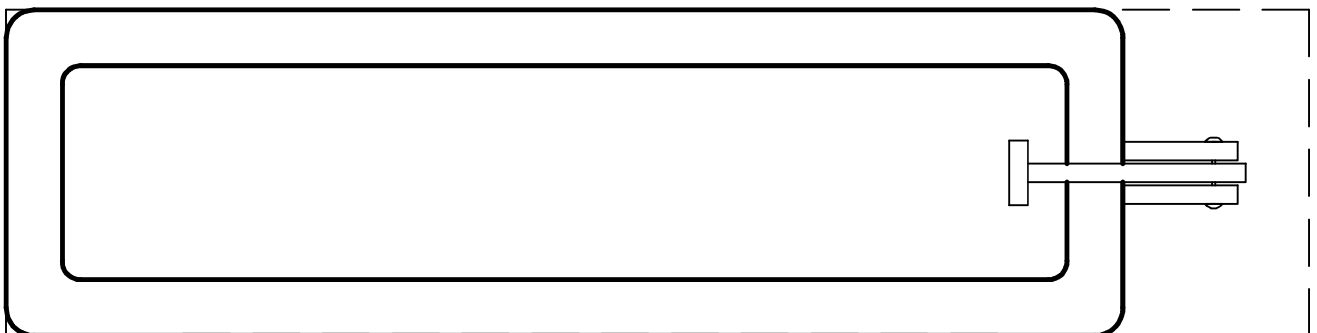

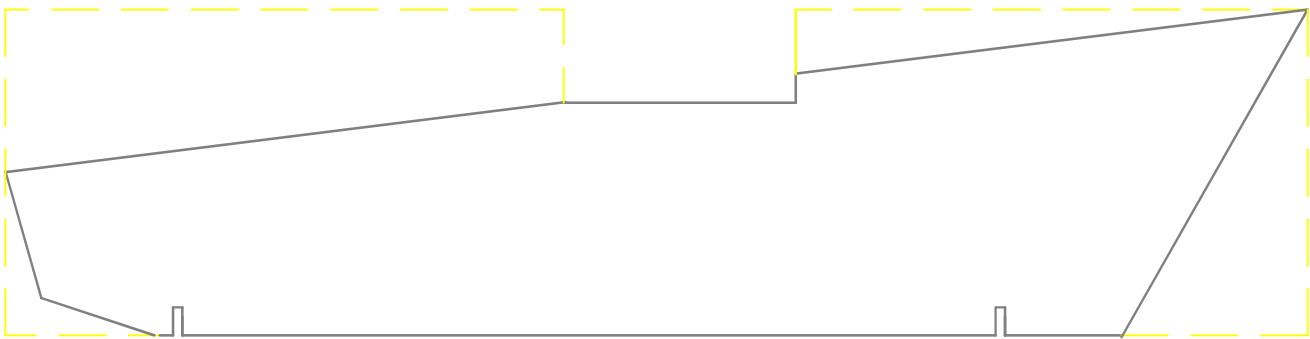
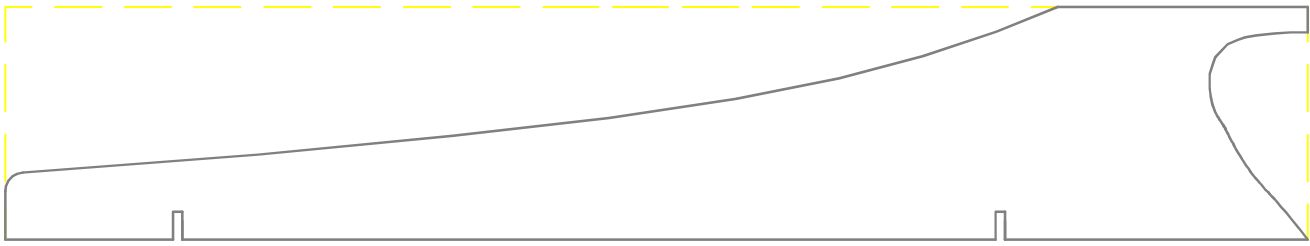
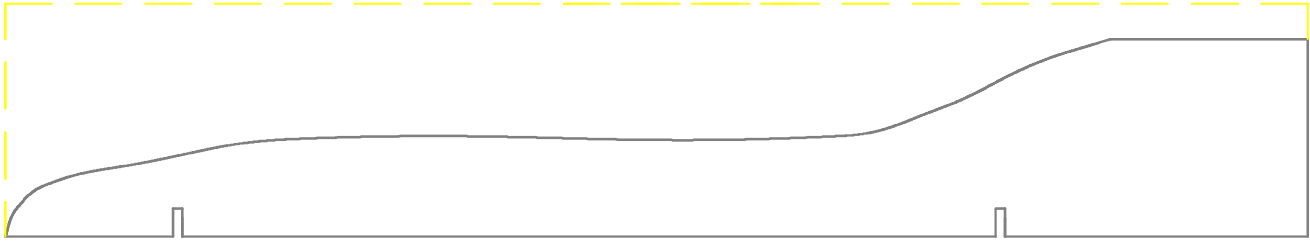

OLD STYLE BLOCK

MINIMOUSE – CUT PROFILE THEN SHAPE BODY

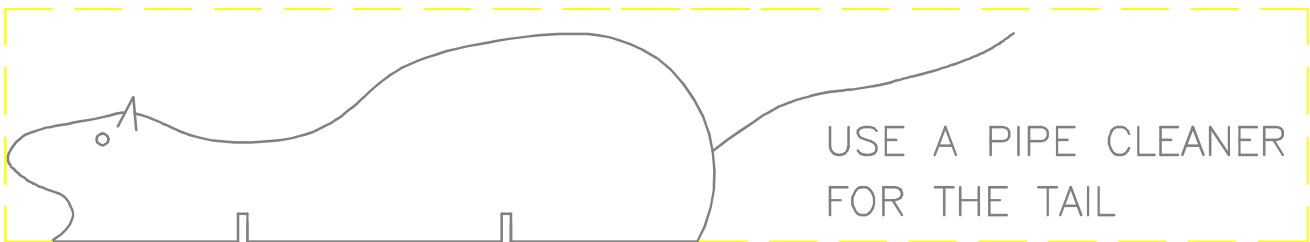

USE A PIPE CLEANER FOR THE TAIL

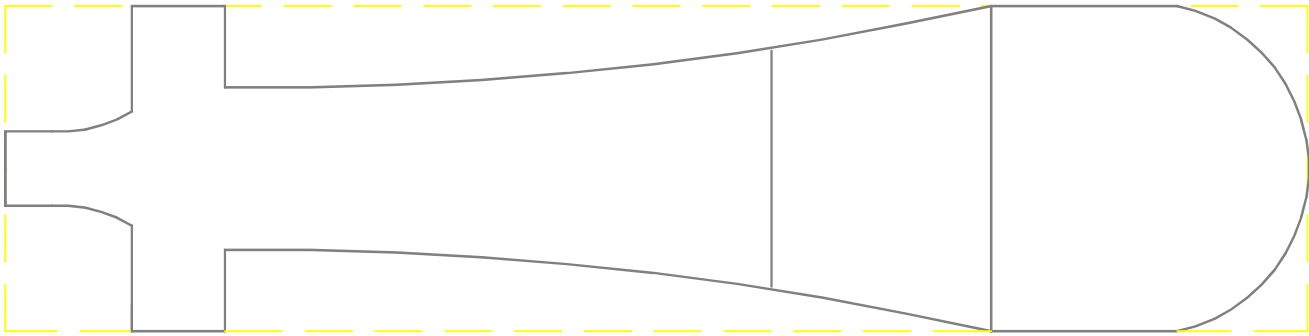
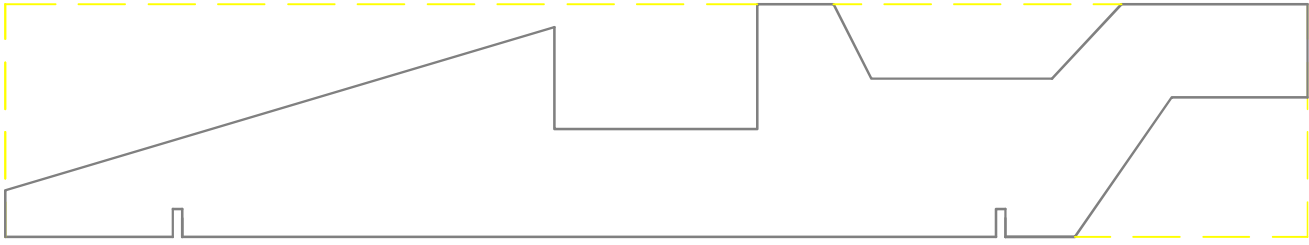

"DRAGSTER TOP VIEW"

"DRAGSTER"

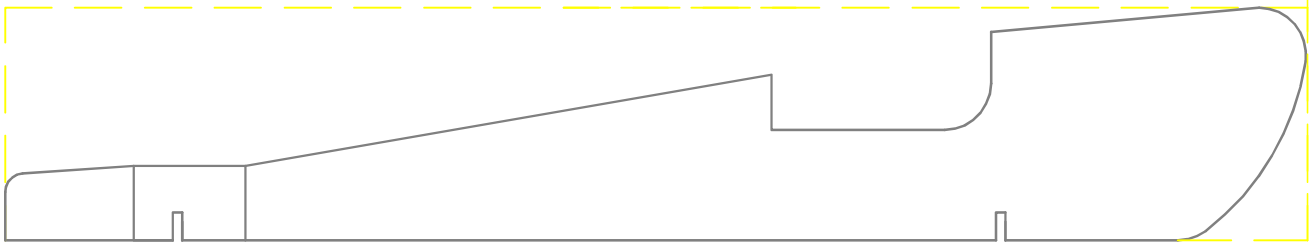

"SLOW SHORT STUFF"

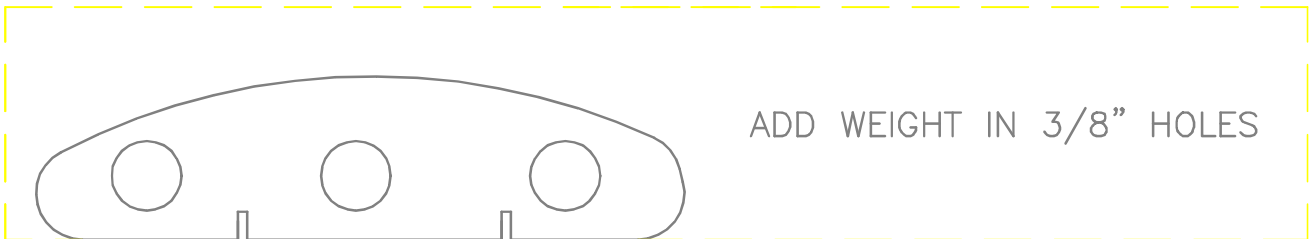

ADD WEIGHT IN 3/8" HOLES

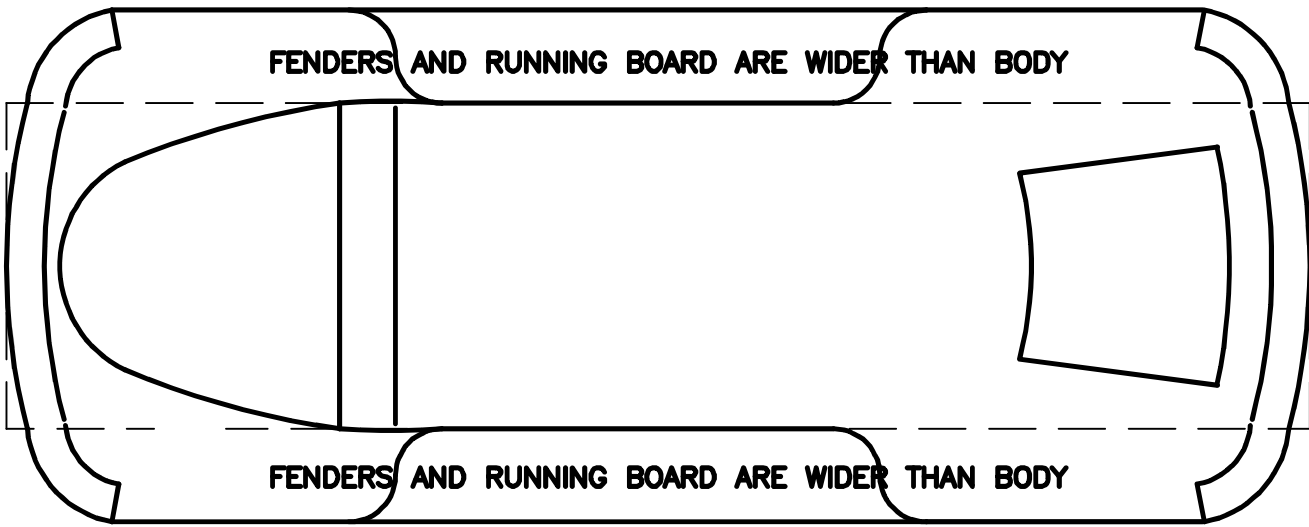

"BUG TOP VIEW"

ADD EXTRA WOOD FOR HEIGHT AND WIDTH

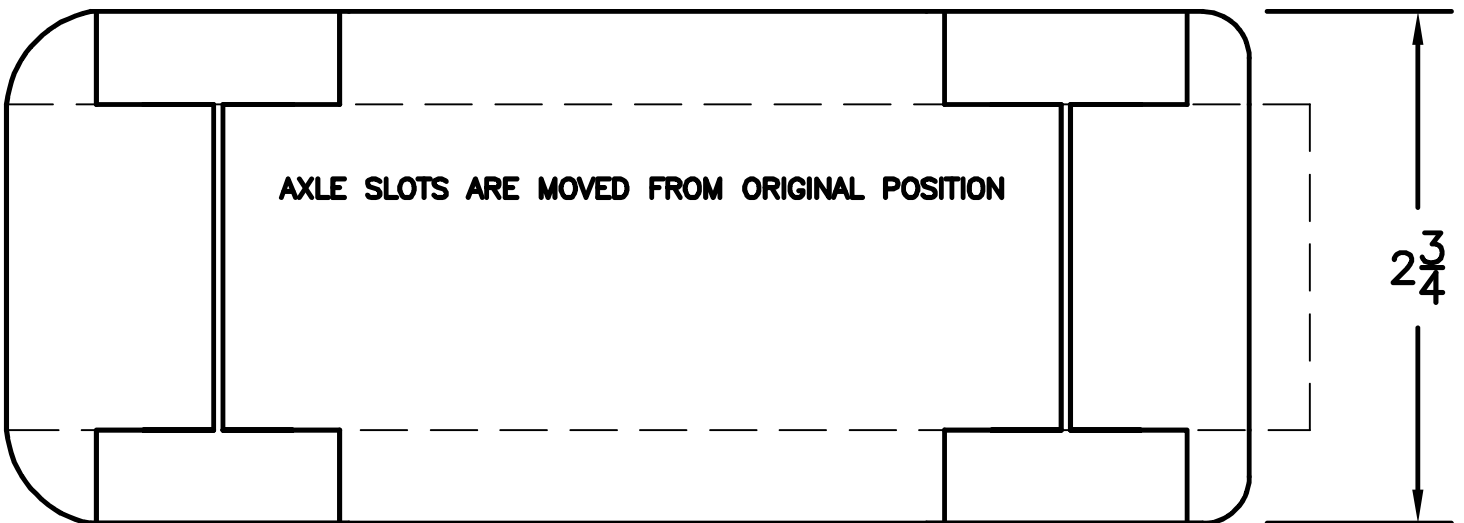
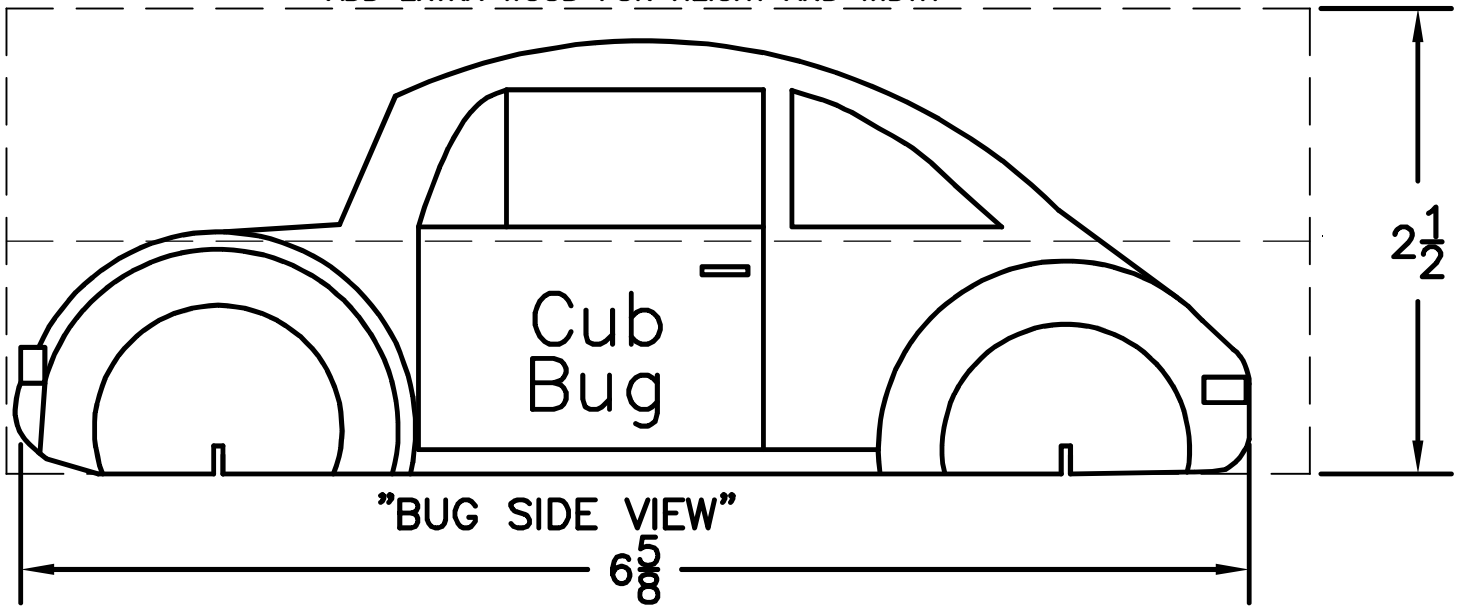

"BUG BOTTOM VIEW"

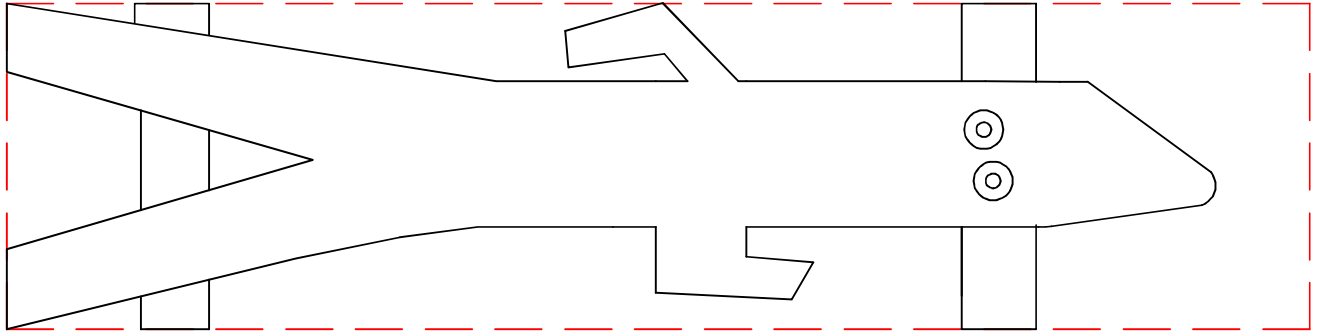

GUMBY

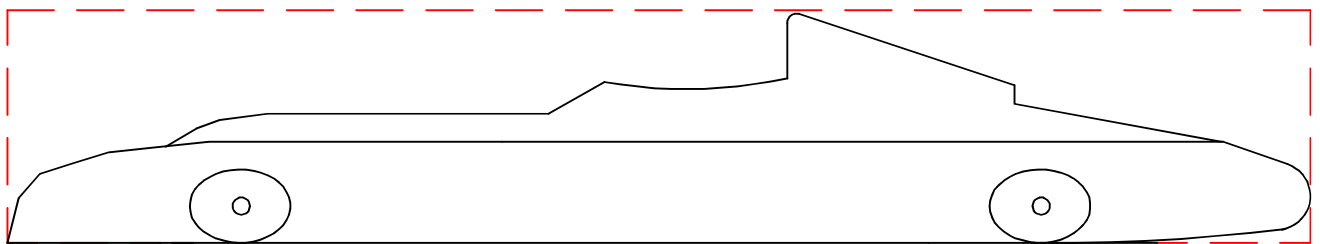
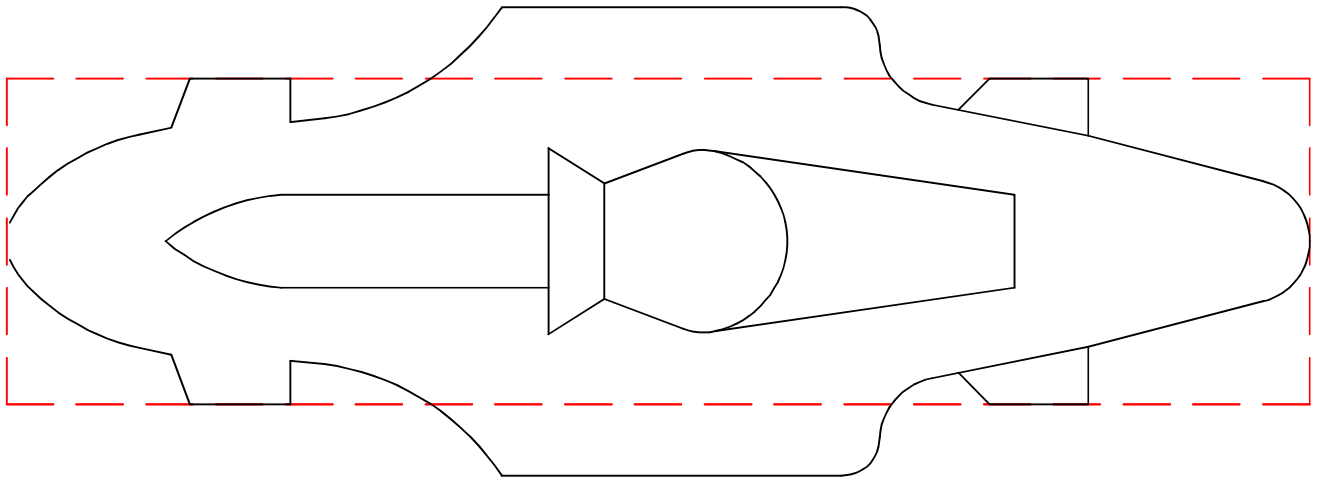
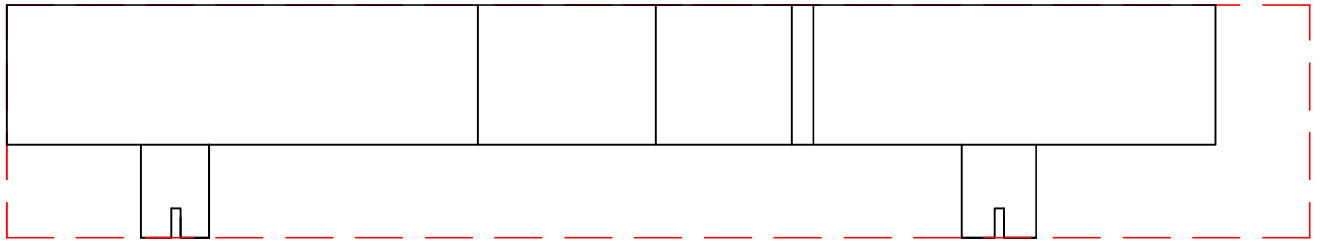

THE CRAYON CAR CAN BE CUT FROM THE STANDARD BLOCK THEN ROUTED TO REMOVE WOOD TO PROVIDE SPACE FOR ACTUAL CRAYONS TO BE INSERTED AS SHOWN. THE PAINT SCHEME COLORS DEPICT REALISTIC COLORS THAT MIGHT BE FOUND ON COMMERCIAL BOXES.

